

## QRPGuys No Tune End Fed Half Wave Antenna

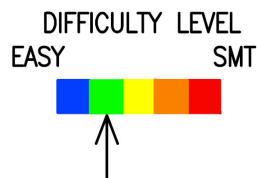
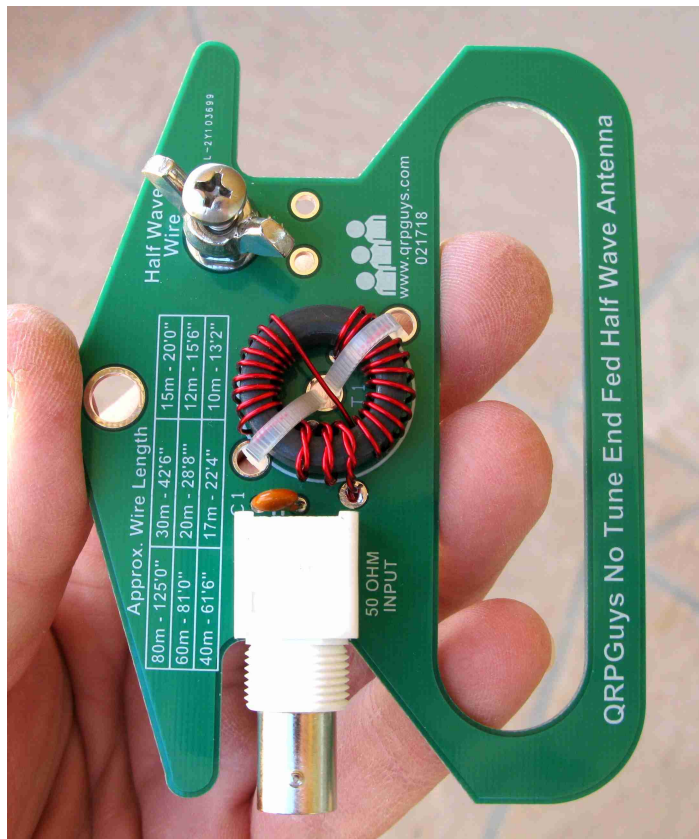

First, familiarize yourself with the parts and check for all the components. If a part is missing, please contact us and we will send one. To request a part, please use [qrpguys.parts@gmail.com](mailto:qrpguys.parts@gmail.com).

*Please read all the instructions before starting the assembly.*

### Parts List

- 1 – QRPGuys half wave wire antenna pcb
- 1 – T1, Ø.82 ferrite toroid core (black)
- 1 – 36" of 22AWG magnet wire
- 1 – 150pF ceramic capacitor, marked 151, 150K, or 150P depending on manufacturer
- 1 - BNC PCB horizontal connector
- 1 – 8-32 x 3/4" L SS Phillips pan head screw
- 2 – 8-32 SS nut
- 1 – #8 internal tooth SS lock washer
- 1 – 8-32 SS wing nut
- 2 – nylon tie wrap

Refer to the graphic below and the PCB silk screening for the placement of the components.

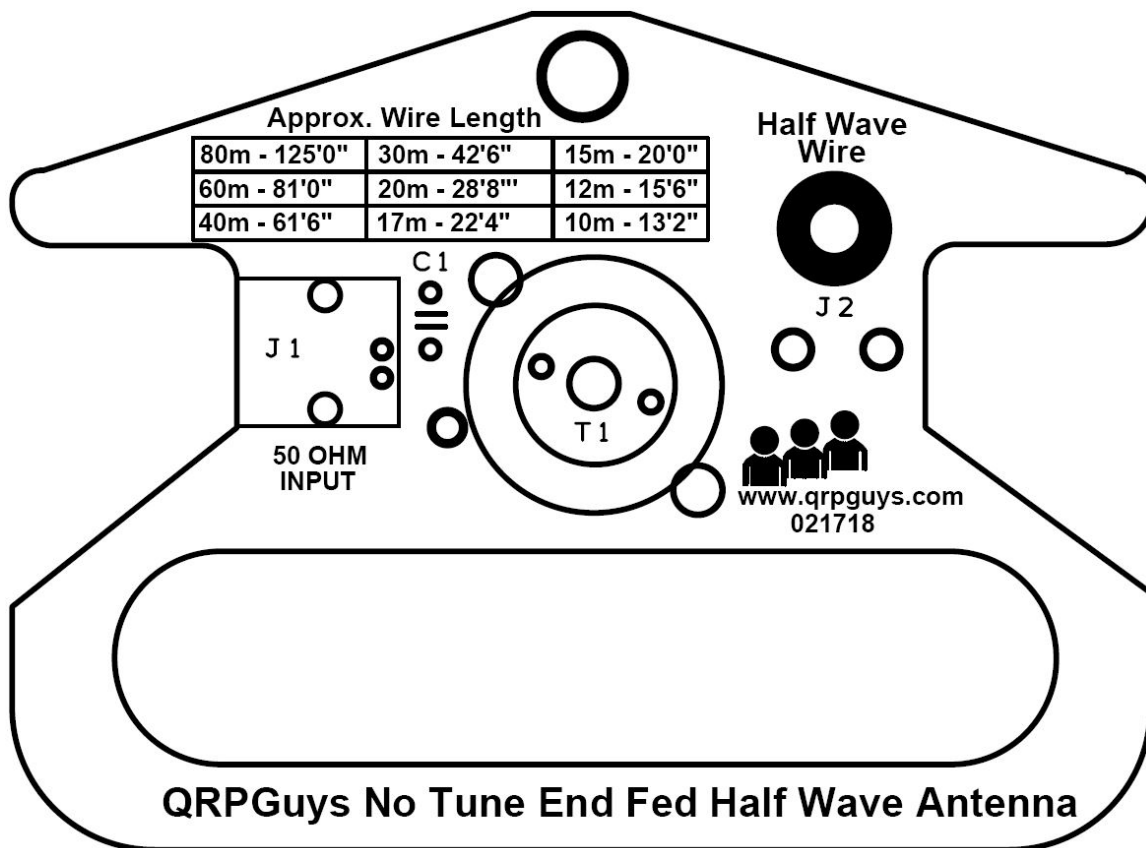

- [ ] Install 150pF ceramic capacitor, marked 151, 150K, or 150P depending on manufacturer
- [ ] Install the horizontal BNC connector
- [ ] Install the hardware post for the antenna wire on the top of the board, as shown in the figure below. The post screw should be flush with the outside of the securing nut on the bottom side.

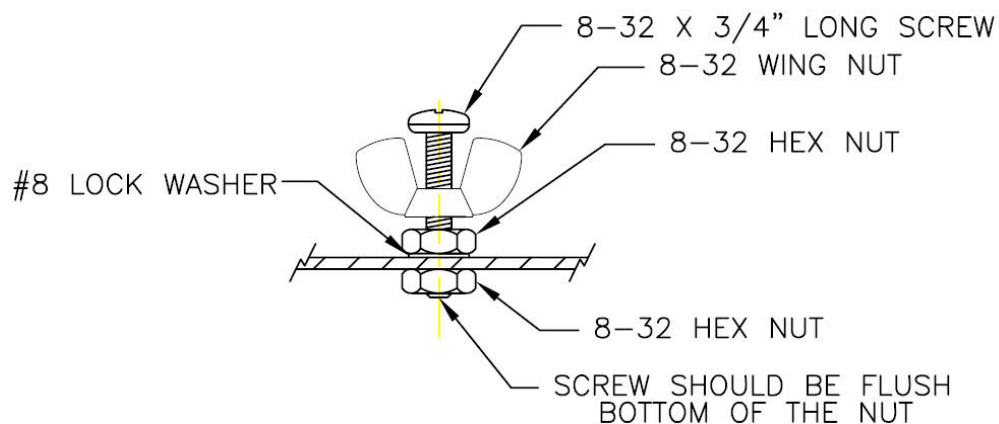

## T1 preparation

Following the instructions below will allow the transformer to align with the pcb holes and perform properly.

- [ ] Start by scraping the insulation with a razor knife .50" from the end, and a space between 3.25" and 4.25", as shown in the picture below.



- [ ] Fold back the wire 3.75", and pinch the loop. As shown below. This will leave .50" of exposed bare wire. Pinch the loop so it will pass through the pcb hole at assembly.

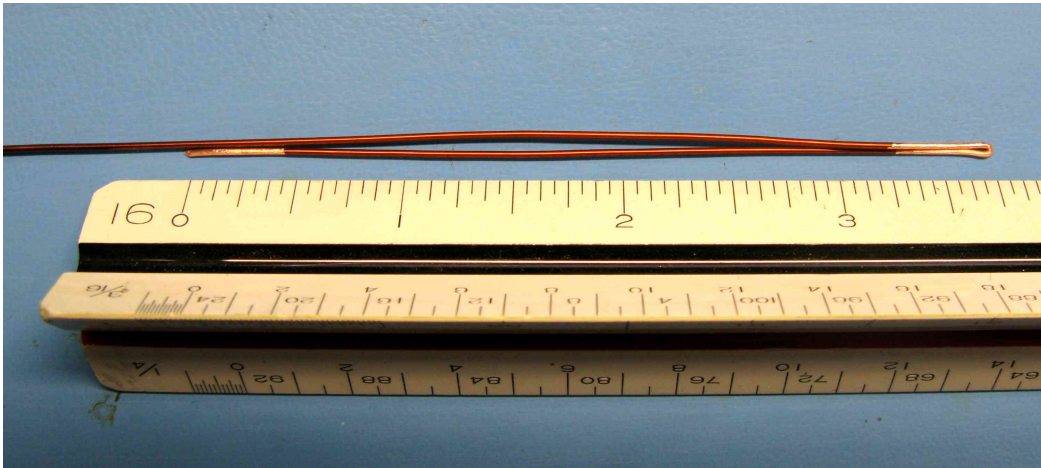

- [ ] Hold the end of the loop, and twist the loop as shown.

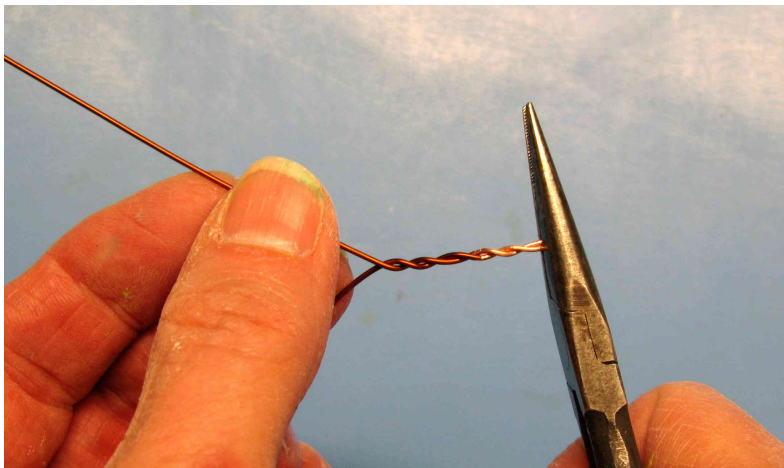

- [ ] Twist the loop until you get to the beginning of the .50" scraped end.

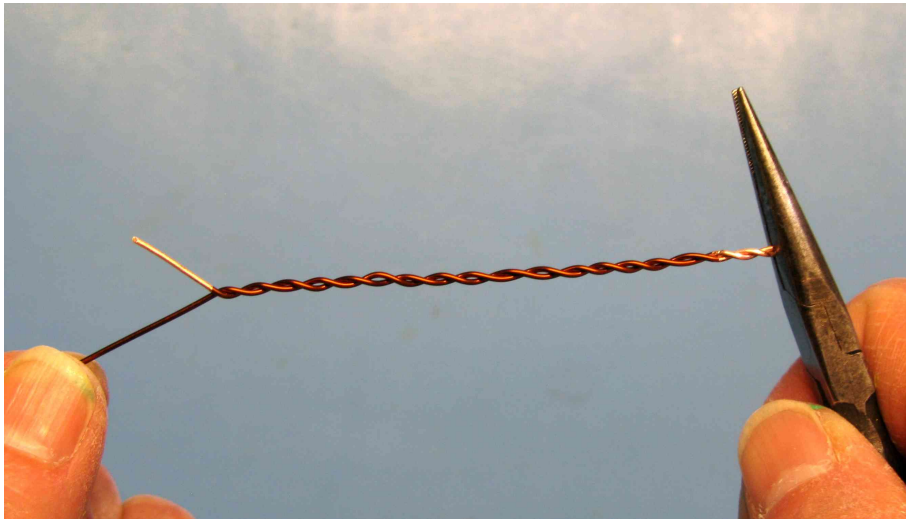

- [ ] Place the looped end of the wire up through the inside of the FT82-43 toriod as shown.

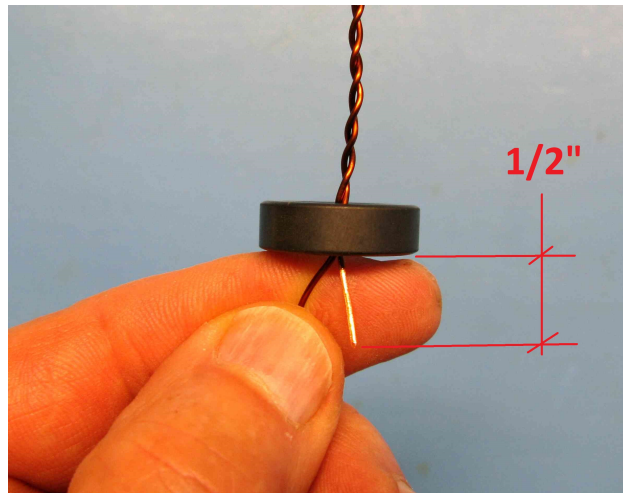

- [ ] With the .50" exposed end of the wire just below the core, as shown, bend the wire down to form the first of the three primary turns and the first of the secondary turns. This is **turn one** of the primary and secondary.

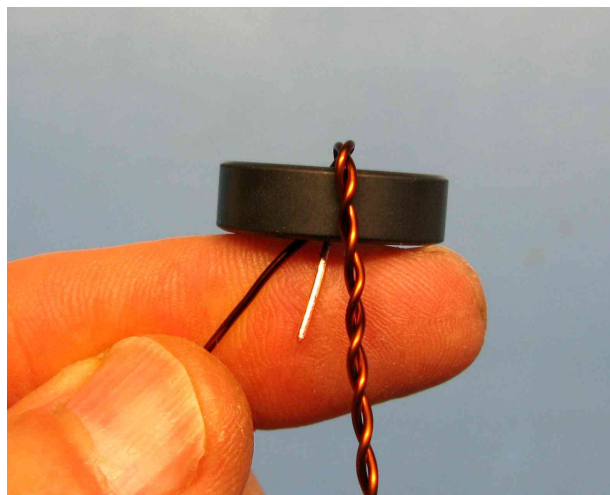

- [ ] Pass the looped end of the wire **up** through the center of the toroid, and wind two more turns to the right (counterclockwise), for a total of a **three turns**. At this point the primary is finished



- [ ] Continue winding the secondary with the loose end of the wire passing **down** through the center of the core, winding (clockwise). The picture below shows first 12 turns of what will be a total of 24 turns for the secondary



- [ ] The next turn will cross down through the center of the core 180° and cross to the other side of the toroid as shown. Because it goes thru the center of the core, it counts as the **13th turn** of the secondary.



- [ ] Now pass the wire **down** through the center of the core and wind in a counterclockwise Direction for another 11 turns. This will result in total of a **24 turn** secondary, as shown below.

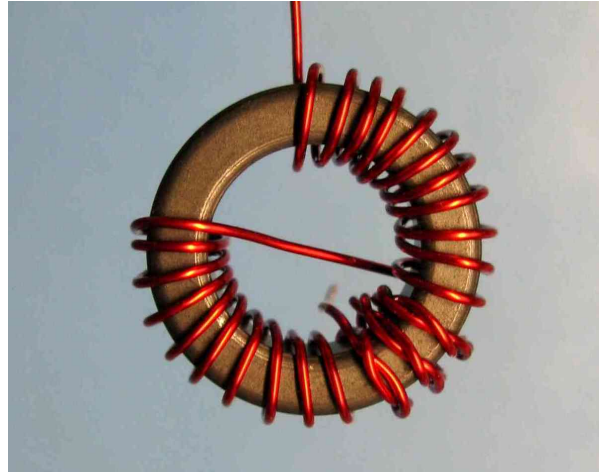
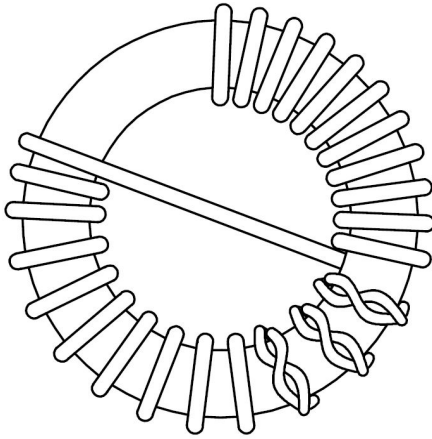

- [ ] Verify your total turn count and trim the loose end to .50" and scrape the enamel off of the end, and tin the three exposed leads of T1 before installing.

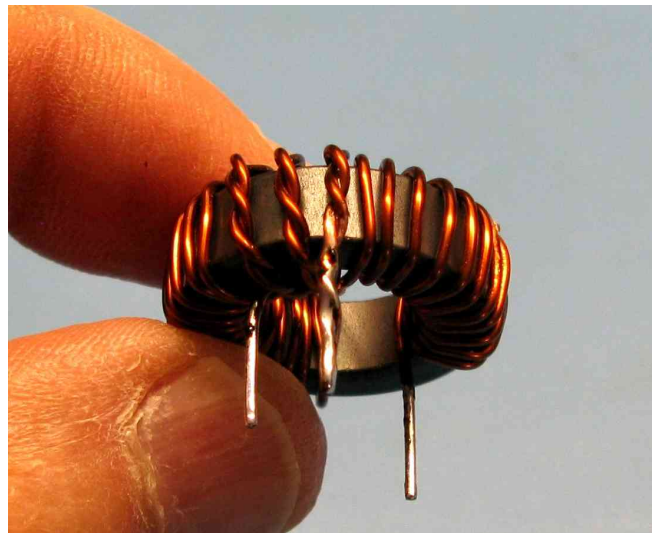

Completed T1

- [ ] Install T1 on the top of the pcb flush with the surface, clip the leads flush, and secure it with the two nylon ties as shown below.

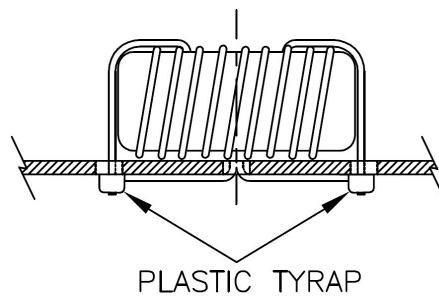

Shown below is the strain relief routing for the driven element wire.

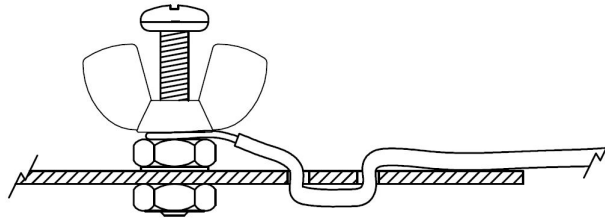

### Using the antenna:

### **Use all the normal cautions throwing wires up in the air near power lines.**

The QRPGuys Half Wave Wire Antenna covers any single band from 80m – 10m with the correct length  $1/2\lambda$  wire. The wire can be trimmed so the SWR is  $\leq 1.2$  for a given frequency, but may require a tuner to achieve that for the entire band. We have found when trimmed to the center of the band, the entire band is  $\leq 2.0$  SWR, with the exception of 80m. For 80m decide on which end of the band you need the lowest SWR, and trim accordingly. There is no additional counterpoise required, as the feed line acts as the counterpoise. Start by using the length of wire detailed on the pcb. It is best to cut your wire a little longer and fold it back on itself during the tuning process. You can use 20awg to 24awg depending what you have available. The driven element may be deployed horizontally, in a inverted V configuration, or vertically for the higher bands, if desired. There is a BNC female connector for the input from your radio or tuner and a 1/4' diameter hole to secure the pcb to whatever is handy. The lengths on the pcb reflect what we have tested. It would be wise to add a couple feet and trim to your local conditions.

Depending on the gauge wire you use and band, you can keep the wire attached to the device at all times using the built-in strain reliefs and wind the driven element wire around the pcb for compact storage.

The results below reflect my test in AZ with poor ground conductivity with a gradual sloper configuration for the lower bands, to near vertical for the upper bands. There can be some significant changes in length due to your environment. Your results can vary depending on local conditions and wire deployment.

80m – 125'0" wire, 3.550 MHz 1.3 SWR, 3.450-3.660MHz  $\leq 2.0$  SWR

60m – 81'0" wire, 5.350 MHz 1.2 SWR

40m – 61'6" wire, 7.100 MHz 1.1 SWR, 6.900-7.300MHz  $\leq 2.0$  SWR

30m – 42'6" wire, 10.100 MHz 1.1 SWR

20m – 28'8" wire, 14.200 MHz 1.2 SWR, 13.700-14.600MHz  $\leq 2.0$  SWR

17m – 22'4" wire, 18.100 MHz 1.0 SWR, 17.500-18.600MHz  $\leq 2.0$  SWR

15m – 20'0" wire, 21.100 MHz 1.2 SWR, 20.500-21.900MHz  $\leq 2.0$  SWR

12m – 15'6" wire, 24.900 MHz 1.2 SWR, 23.600-26.400MHz  $\leq 2.0$  SWR

10m – 13'2" wire, 28.100 MHz 1.2 SWR, 26.400-31.700MHz  $\leq 2.0$  SWR

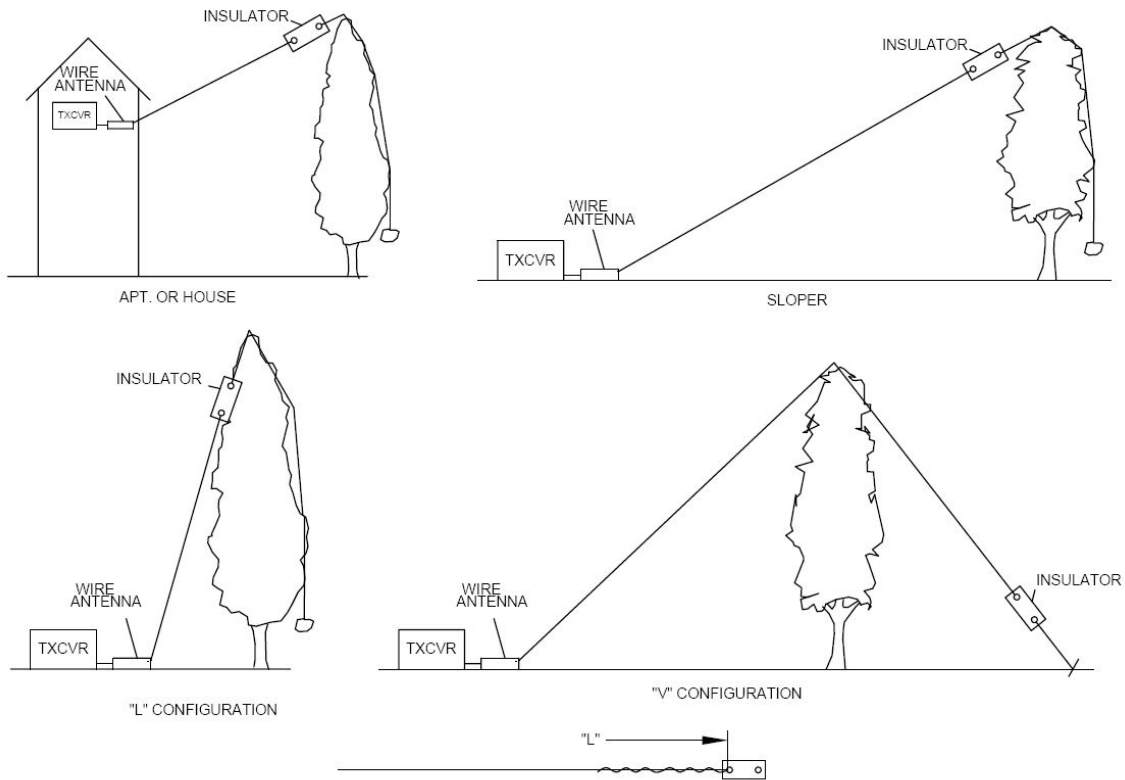

ALWAYS CUT YOUR ACTIVE ELEMENT 1 OR 2 FT. LONGER AND WRAP IT BACK UPON ITSELF. THIS LEAVES SOME WIRE FOR ADJUSTMENT. IT STOPS RADIATING AT THE POINT OF THE BEND AT THE INSULATOR. THE INSULATOR CAN BE A SIMPLE 2" LONG PIECE OF PLASTIC TUBING WITH A COUPLE OF HOLES IN IT.

**Schematic:**

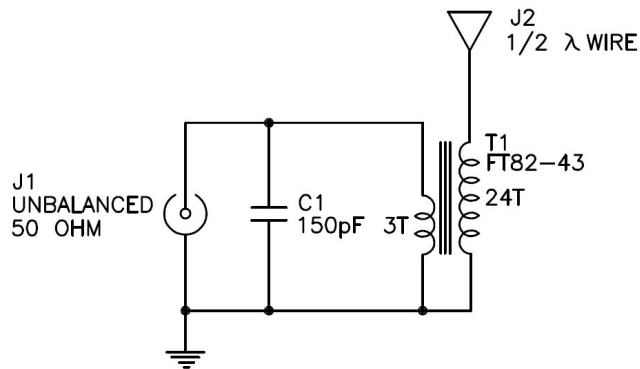

**Notes:**

---



---



---



---



---